

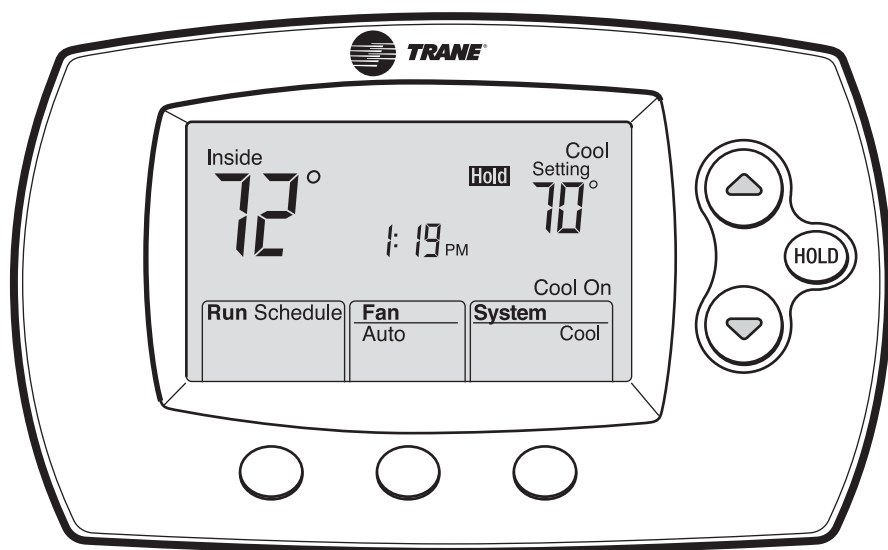

TCONT600AF11MA

Programmable Comfort Control

Installation Instructions



Pub. No. 18-HD25D20-3



69-1834-2



Product Application

This Comfort Control provides electronic control of 24 VAC single-stage heating and cooling systems.

System Types

- Gas, oil or electric heat with air conditioning
- Warm air, hot water, high-efficiency furnaces, heat pumps
- Heat only with fan
- Cool only

Power

- Common wire only
- Common wire with battery backup

Changeover Options

- Selectable manual or auto-changeover modes

System Settings

- Heat, Off, Cool, Auto

Fan Settings

- Auto, On

Must be installed by a trained, experienced technician

- Read these instructions carefully. Failure to follow these instructions can damage the product or cause a hazardous condition.
- Check the ratings in this booklet to verify that this product is suitable for your application (see page 12).
- Always test for proper operation after installation (see page 8).



CAUTION: ELECTRICAL HAZARD

Can cause electrical shock or equipment damage. Disconnect power before beginning installation.



MERCURY NOTICE

If this product is replacing a control that contains mercury in a sealed tube, do not place the old control in the trash. Contact your local waste management authority for instructions regarding recycling and proper disposal.

Table of contents

Installation

Pre-installation checklist	2
Wallplate installation	3
Wiring	4
Wiring diagrams	5
Power options	6
Comfort Control mounting	6

Setup and testing

Installer setup	7
Installer system test	8
Explanation of features	9

Appendices

Quick reference to controls	10
Quick reference to display	10
Battery replacement	10
In case of difficulty	11
Accessories/replacement parts	12
Specifications	12

Installation tips

Install the Comfort Control about 5 feet (1.5m) above the floor in an area with good air circulation at average temperature.

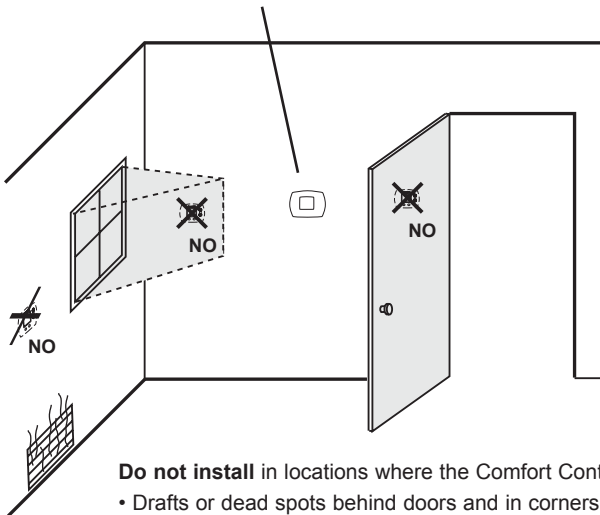

Do not install in locations where the Comfort Control can be affected by:

- Drafts or dead spots behind doors and in corners
- Hot or cold air from ducts
- Sunlight or radiant heat from appliances
- Concealed pipes or chimneys
- Unheated/uncooled areas such as an outside wall behind the Comfort Control

Pre-installation checklist

Package contents

Check to make sure your package includes the following items:



**Programmable
Comfort Control**
(wallplate attached to back)



**Quick
reference
card**



Owner's Guide



**Wall anchors and
mounting screws**
(2 each)



**AA alkaline
batteries (2)**

Required tools & supplies

- No. 2 Phillips screwdriver
- Small pocket screwdriver
- Drill
- Drill bit (3/16" for drywall, 7/32" for plaster)
- Hammer
- Pencil
- Electrical tape
- Level (optional)

Wallplate installation

Remove battery holder.
Pull here to remove wallplate from new Comfort Control.

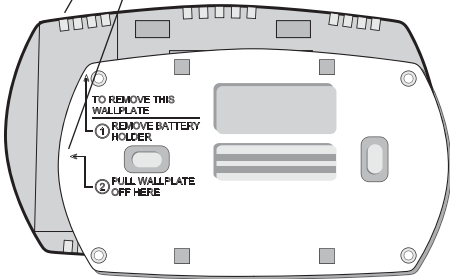

Insert quick reference card

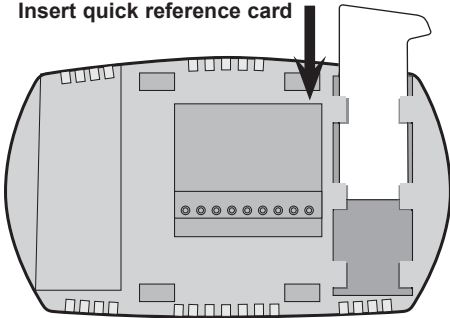

Drill 3/16" holes for drywall.
Drill 7/32" holes for plaster.

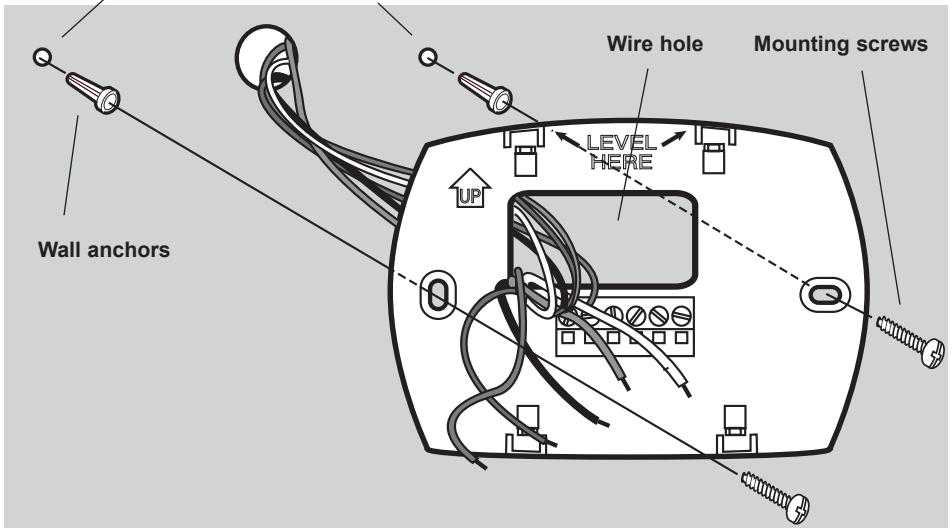

Remove the wallplate from the Comfort Control as shown at left, then follow directions below for mounting.

- 1 Insert quick reference card in slot in back of Comfort Control.
- 2 Pull wires through wire hole.
- 3 Position wallplate on wall, level and mark hole positions with pencil.
- 4 Drill holes at marked positions as shown below, then tap in supplied wall anchors.
- 5 Place wallplate over anchors, insert and tighten mounting screws.

Wiring



CAUTION: ELECTRICAL HAZARD. Can cause electrical shock or equipment damage. Disconnect power before wiring.

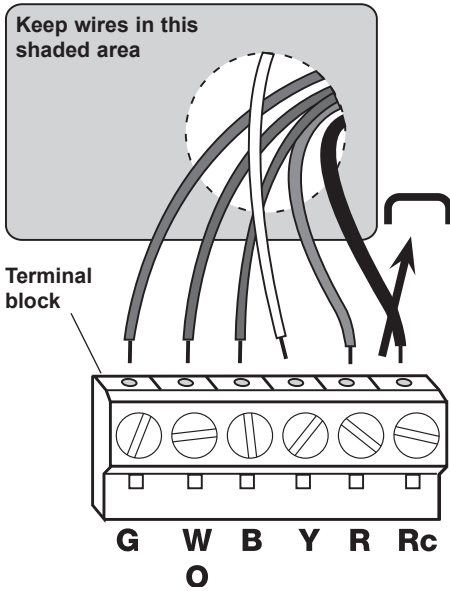

NOTES

R & Rc terminals

In single-transformer system, leave metal jumper in place between R & Rc. Remove metal jumper if two-transformer system.

B terminal

B is the common wire terminal.

W (O) terminal

If Comfort Control is configured for a heat pump in the Installer Setup, changeover valve is configured for cool ("O" factory setting).

Wire specifications

Use 18- to 22-gauge thermostat wire.
Shielded cable is not required.

Wiring

- 1 Loosen screw terminals, insert wires into terminal block, then re-tighten screws.
- 2 Push excess wire back into the wall opening. Keep wires in shaded area as shown at left.
- 3 Plug the wall opening with non-flammable insulation to prevent drafts from affecting Comfort Control operation.

Terminal Designations

G Fan relay.

W (O) Heat relay or changeover valve terminal for heat pumps.

B Common wire from secondary side of cooling system transformer.

Y Compressor contactor.

R Heating power. Connect to secondary side of heating system transformer.

Rc Cooling power. Connect to secondary side of cooling system transformer.

Wiring diagrams

- ⚠️ **Factory-installed jumper. Remove for 2-transformer systems only.**
 - Provide Power Supply disconnect means and overload protection as required.
- ⚠️ **In Installer Setup, set system type to Heat Pump.**

Typical 1H/1C system: 1 transformer

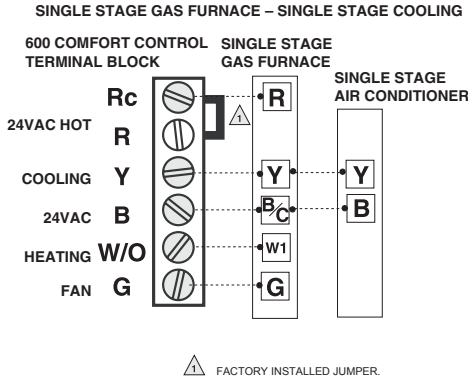

Typical 1H/1C system: 2 transformers

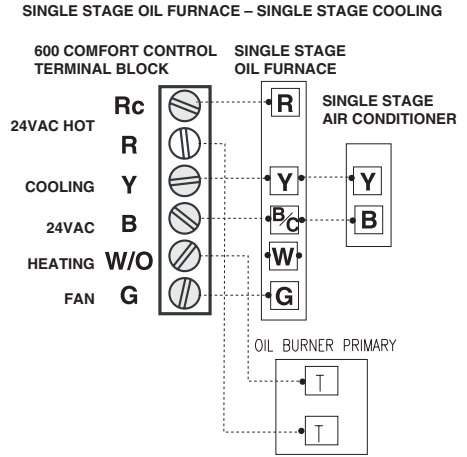

Typical 1H/1C heat pump system:

- ⚠️ **HEAT PUMP – AIR HANDLER 1H/1C**

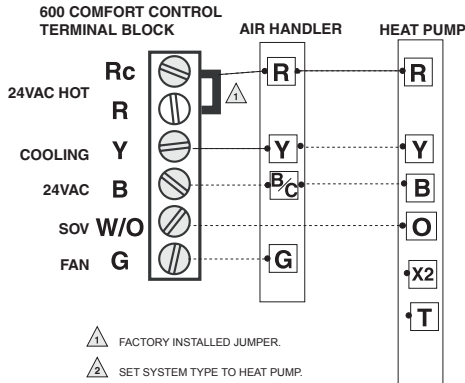

Power options & mounting

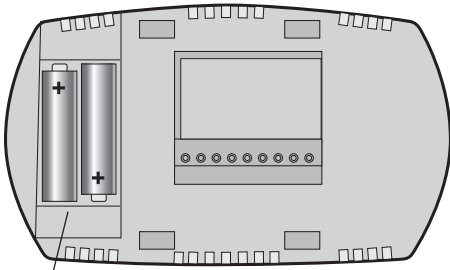
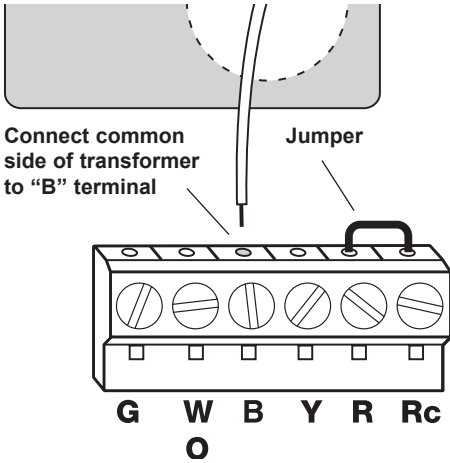

Install batteries in back of thermostat (optional if AC powered).

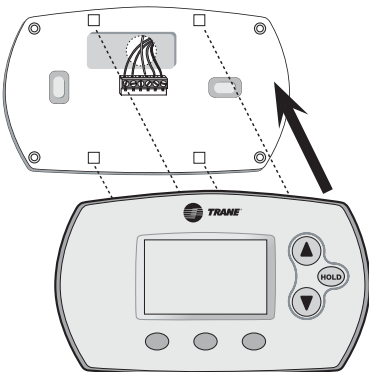

AC Power

The Comfort Control must be powered by 24 VAC power.

To wire the Comfort Control for AC power, connect the common side of the cooling transformer to the "B" terminal as shown at left.

Important: Remove R/Rc jumper for 2-transformer systems only. (See wiring diagram on page 5.)

Battery Backup Power

The Comfort Control can be powered by backup batteries when used with AC power. During power interruptions the batteries will save time/day settings and power the display.

After installation, batteries can be changed without removing the Comfort Control from the wall (see page 10).

To Mount Comfort Control

Align the 4 tabs on the wallplate with corresponding slots on the back of the Comfort Control, then push gently until the Comfort Control snaps in place.

Installer setup

Follow the procedure below to configure the Comfort Control to match the installed heating/cooling system, and customize feature operation as desired.

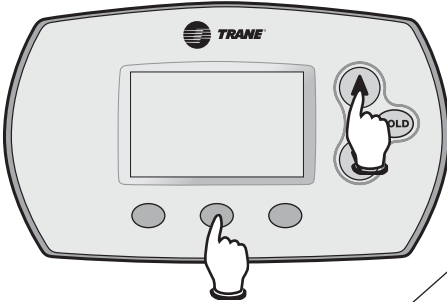

To begin, press and hold the ▲ and FAN buttons until the display changes

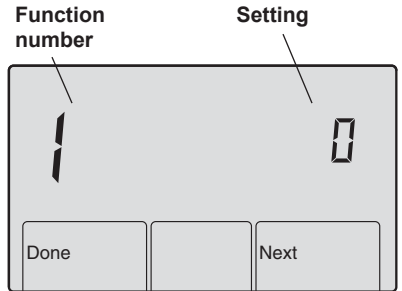

Press ▲ or ▼ to change settings
 Press NEXT to advance to next function
 Press DONE to exit and save settings

Setup Function

Settings & Options (BOLD is “as shipped” settings)

- | | |
|---|--|
| <p>1 System type</p> | <p>0 Gas, oil or electric heat with air conditioning
 1 Heat pump
 2 Heat only (2-wire systems/power to open & close zone valves/ normally open zone valves)
 3 Heat only with fan
 4 Cool only</p> |
| <p>3 Fan control (heating)</p> | <p>0 Gas or oil furnace — equipment controls fan in heating
 1 Electric furnace — Comfort Control controls fan in heating</p> |
| <p>5 Heating cycle rate (CPH: cycles/hour)</p> | <p>5 For gas or oil furnaces of less than 90% efficiency
 1 For steam or gravity systems
 3 For hot water systems & furnaces of over 90% efficiency
 9 For electric furnaces
 [Other cycle rate options: 2, 4, 6, 7, 8, 10, 11 or 12 CPH]</p> |
| <p>9 Compressor cycle rate (CPH)</p> | <p>3 Recommended for most compressors
 [Other cycle rate options: 1, 2, 4, 5 or 6 CPH]</p> |
| <p>12 System setting adjustment</p> | <p>0 Manual changeover (Heat/Cool/Off)
 1 Auto changeover (Heat/Cool/Auto/Off) **See page 9
 2 Auto changeover only (Auto) **See page 9</p> |
| <p>13 Adaptive Intelligent Recovery™</p> | <p>1 On **See page 9
 0 Off</p> |
| <p>14 Temperature display</p> | <p>0 Fahrenheit
 1 Celsius</p> |
| <p>15 Compressor protection</p> | <p>5 Five-minute compressor off time **See page 9
 [Other options: 0, 1, 2, 3 or 4-minute off time]</p> |
| <p>16 Schedule format</p> | <p>0 5/2 (programmable weekdays and weekends)
 1 5/1/1 (weekdays, Saturday & Sunday programmable)</p> |
| <p>27 Heat temperature range stops</p> | <p>90 Highest heating temperature setting
 40-89 Heating temperature range (increments of 1°F, or 0.5°C)</p> |
| <p>28 Cool temperature range stops</p> | <p>60 Lowest cooling temperature setting
 61-99 Cooling temperature range (increments of 1°F, or 0.5°C)</p> |
| <p>31 Dehumidification Control</p> | <p>1 Cooling Droop
 2 Cooling Droop with Comfort-R™ (15 seconds Fan Delay)
 3 Cooling Droop with Comfort-R™ (30 seconds Fan Delay)
 0 None</p> |

Installer system test

Follow the procedure below to test the heating, cooling and fan.

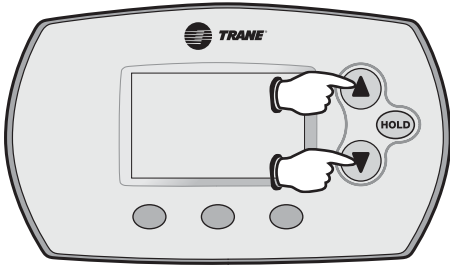

To begin, press and hold the ▲ and ▼ buttons until the display changes

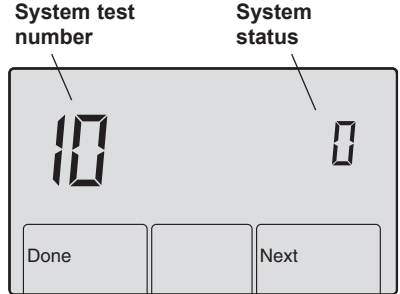

Press ▲ to turn on system
Press ▼ to turn off system
Press NEXT to advance to next test
Press DONE to terminate system test

System Test

System Status

10 Heating system	0 Heat and fan turn off. 1 Heat turns on. Fan also turns on immediately if Function 1 or 3 is set to "1" (see page 7).
30 Cooling system	0 Compressor and fan turn off. 1 Compressor and fan turn on.
40 Fan system	0 Fan turns off. 1 Fan turns on.
70 Comfort Control information (for reference only)	71 Software revision number (major revisions) 72 Software revision number (minor revisions) 73 Configuration identification code (major) 74 Configuration identification code (minor) 75 Production configuration date code (week) 76 Production configuration date code (year)



CAUTION: EQUIPMENT DAMAGE HAZARD

Compressor protection (minimum off time) is bypassed during testing. To prevent equipment damage, avoid cycling the compressor quickly.

Auto Changeover (Setup Function 12)

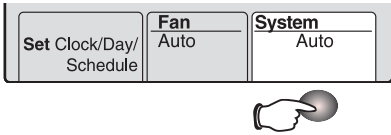

Auto Changeover is a feature used in climates where both air conditioning and heating are used on the same day. When the system is set to Auto, the Comfort Control automatically selects heating or cooling depending on the indoor temperature.

Heat and cool settings must be at least 3 degrees apart. The Comfort Control will automatically adjust settings to maintain this 3-degree separation (called “deadband”).

The 3-degree separation between heating and cooling set temperatures is fixed, and cannot be changed.

Adaptive Intelligent Recovery™ (Setup Function 13)

Adaptive Intelligent Recovery eliminates guesswork when setting your schedule. It allows the Comfort Control to “learn” how long your furnace and air conditioner take to reach the temperature you want.

Just set your program schedule to the time you want the house to reach your desired temperature. The Comfort Control then turns on the heating or cooling at just the right time to reach your scheduled temperature at your scheduled time.

For example: Set the Wake time to 6 am, and the temperature to 70°. The heat will come on before 6 am, so the temperature is 70° by the time you wake at 6.

Built-in compressor protection (Setup Function 15)

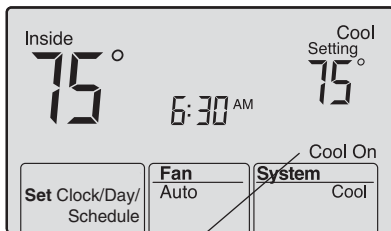

Message flashes until safe restart time has elapsed

This feature helps prevent damage to the compressor in your air conditioning or heat pump system.

Damage can occur if the compressor is restarted too soon after shutdown. This feature forces the compressor to wait for a few minutes before restarting.

During the wait time, the message Cool On or Heat On (heat pumps only) will flash on the display. When the safe wait time has elapsed, the message stops flashing and the compressor turns on.

Quick reference to controls

Digital display screen

Battery holder

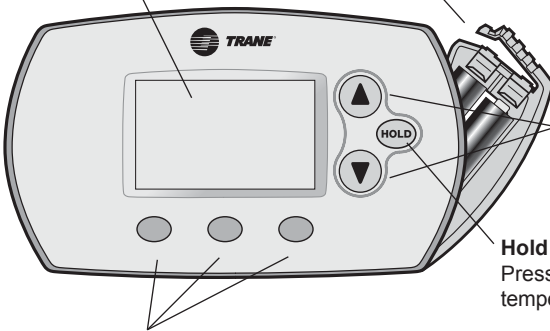

Temperature buttons

Press to adjust temperature settings

Hold button

Press to override programmed temperature control

Function buttons

Press to select the function displayed just above each button.
(Functions change depending on the task.)

Quick reference to display screen

Current inside temperature

Low battery warning

Current time/day

Current program period
Wake/Leave/Return/Sleep

Set Clock/Day/Schedule
Press to set time, day or program schedules.

Function buttons

Press the button beneath each function to view or change settings. (Functions change depending on the task.)

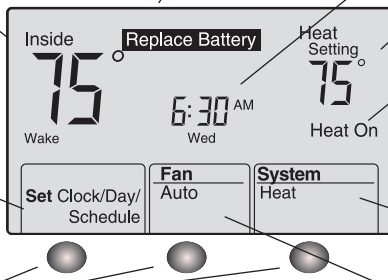

Temperature setting

System status

On when "calling" for heating or cooling; flashes when waiting for compressor restart.

System setting

(Heat/Cool/Auto/Off)

Fan setting

(Auto/On)

Battery replacement

Press and pull to remove

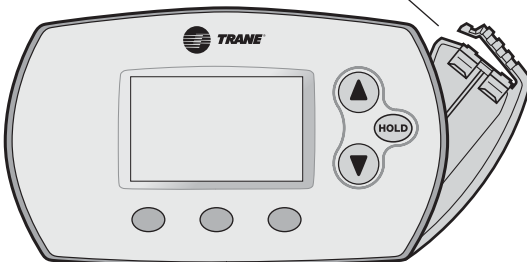

Insert fresh AA alkaline batteries, then reinstall battery holder

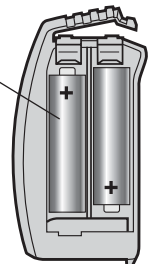

In case of difficulty

If you have difficulty with your Comfort Control, please try the suggestions below. Most problems can be corrected quickly and easily.

- | | |
|--|--|
| Display is blank | <ul style="list-style-type: none">• Check circuit breaker and reset if necessary.• Make sure power switch at heating & cooling system is on.• Make sure furnace door is closed securely. |
| Temperature settings do not change | <p>Make sure heating and cooling temperatures are set to acceptable ranges:</p> <ul style="list-style-type: none">• Heat: 40° to 90°F (4.5° to 32°C).• Cool: 60° to 99°F (15.5° to 37°C). |
| Heating system does not respond (“Heat On” appears on screen) | <ul style="list-style-type: none">• Check for 24 VAC at the equipment on the secondary side of the transformer between power and common. If voltage is not present, check the heating equipment to find the cause of the problem.• Check for 24 VAC between the heat terminal (W) and the transformer common. If 24 VAC is present, the Comfort Control is functional. Check the heating equipment to find the cause of the problem.• Check for loose or broken wires between the Comfort Control and the heating equipment. |
| Cooling system does not respond (“Cool On” appears on screen) | <ul style="list-style-type: none">• Check for 24 VAC at the equipment on the secondary side of the transformer between power and common. If voltage is not present, check the cooling equipment to find the cause of the problem• Check for 24 VAC between the cooling terminal (Y) and the transformer common. If 24 VAC is present, the Comfort Control is functional. Check the cooling system to find the cause of the problem.• Check for loose or broken wires between the Comfort Control and the cooling equipment. |
| Fan does not turn on in a call for heat | <ul style="list-style-type: none">• Check Installer Setup, Function 3 (Fan Control), to make sure the fan control is properly set to match the type of system (see page 7). |
| Heat/cool both on at same time, or heat does not turn off | <ul style="list-style-type: none">• Check Installer Setup, Function 1 (System Type), to make sure it is set to match the installed heating/cooling equipment (see page 7).• Check to make sure heating and cooling wires are not shorted together. |

In case of difficulty

- Heating equipment is running in cool mode**
 - Check Installer Setup, Function 1 (System Type), to make sure it is set to match the installed heating/cooling equipment (see page 7).

- Cannot change system setting to “Heat”**
 - Check Installer Setup, Function 1 (System Type), to make sure it is set to match the installed heating equipment (see page 7).
 - Change Installer Setup, Function 12 (System Setting) to Manual or Auto Changeover (see page 7).

- Cannot change system setting to “Cool”**
 - Check Installer Setup, Function 1 (System Type), to make sure it is set to match the installed cooling equipment (see page 7).
 - Change Installer Setup, Function 12 (System Setting) to Manual or Auto Changeover (see page 7).

- “Heat On” is not displayed**
 - Change the System Setting to Heat, and set the temperature level above the current room temperature.

- “Cool On” is not displayed**
 - Change the System Setting to Cool, and set the temperature level below the current room temperature.

- “Cool On” or “Heat On” is flashing**
 - Compressor protection timeout is engaged. Wait 5 minutes for the system to restart safely, without damage to the compressor.

Accessories & replacement parts

Please contact your distributor to order replacement parts.

Battery holderPart Number **THT02506**
Cover plate assemblyPart Number **BAYCOVR700A**
 (Use to cover marks left by old thermostats.)

Specifications

Temperature Ranges

- Heat: 40° to 90°F (4.5° to 32°C)
- Cool: 60° to 99°F (15.5° to 37°C)

Operating Ambient Temperature

- 32° to 120°F (0° to 48.9°C)

Shipping Temperature

- -20° to 120°F (-28.9° to 48.9°C)

Operating Relative Humidity

- 5% to 90% (non-condensing)

Physical Dimensions

- 3-9/16" H x 5-13/16" W x 1-1/2" D
- 91 mm H x 147 mm W x 38 mm D

Electrical Ratings

Terminal	Voltage (50/60Hz)	Running Current
W (O) Heating	20-30 VAC	0.02-1.0 A
Y Cooling	20-30 VAC	0.02-1.0 A
G Fan	20-30 VAC	0.02-0.5 A



It's Hard To Stop A Trane.®

6200 Troup Highway
Tyler, TX 75711-9010

www.trane.com