



32-5038-10

# User's Information Guide

---

## Trane CleanEffects™ Whole House Air Filtration System



Congratulations – Your TRANE CleanEffects™ air filtration system is the most advanced, innovative and effective whole house air filtration system on the market today. It is designed to deliver what we call TRANE Air™ throughout your home. It delivers air that is meticulously filtered and cleaned of up to 99.98% of allergens to provide maximum comfort. You and your family can breathe easier than ever before.

# User's Information

---

## FEATURES AND BENEFITS

Congratulations on the purchase of your CleanEffects™ whole house air cleaner. As you already know, your CleanEffects™ air cleaner will outperform even the best HEPA filter, removing an unprecedented 99.98% of airborne allergens that pass through the filter.

Your CleanEffects™ whole house air cleaner can be installed either as part of a Communicating heating and air conditioning system or as part of a traditional 24 volt system.

When installed as part of a Communicating System in which the indoor unit (furnace or air handler), outdoor unit (air conditioner or heat pump), and comfort control are equipped with our exclusive Communicating technology, your system performs a continuous loop of system diagnostics and data output. The Communicating System monitors itself and quickly identifies any operational faults, automatically issuing a service alert.

Your CleanEffects™ whole house air cleaner can also be installed as part of a traditional 24 volt heating and air conditioning system.

Either way the CleanEffects™ whole house air cleaner is installed as part of your total comfort system, you and your family can breathe easier than ever before.

Figure 1. COMPONENTS OF THE TRANE CLEANEFFECTS™

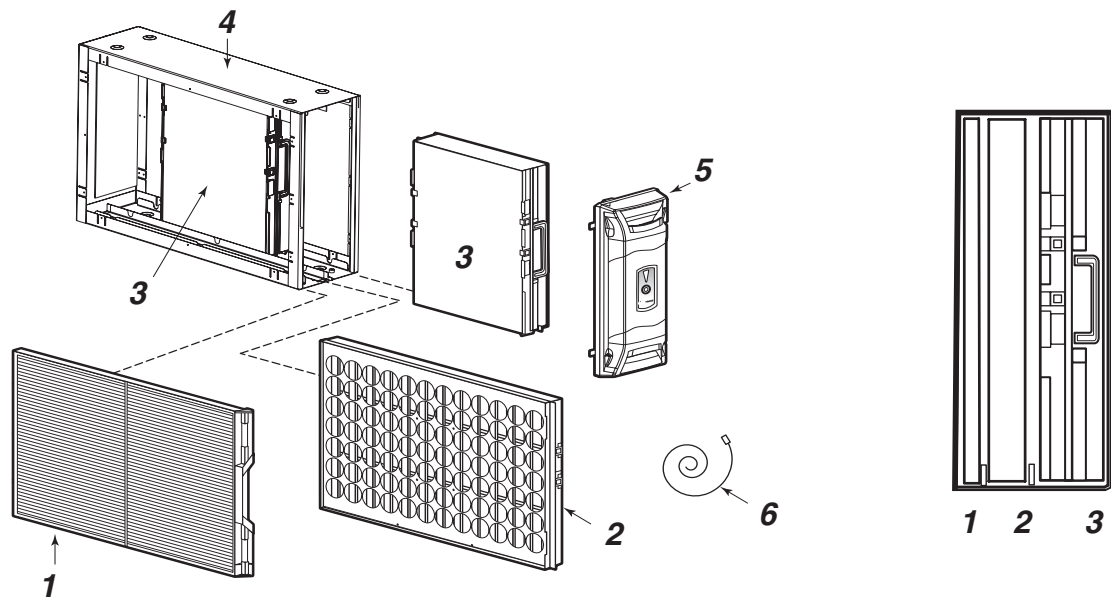

Fig. 1

- 1) **PRE-FILTER** - Traps large particles such as hair and lint before they can enter the COLLECTION CELL section.
- 2) **FIELD CHARGER** - Charges the contaminants. **Only to be removed, cleaned or serviced by a qualified technician.**
- 3) **COLLECTION CELL (2)** - Removes and collects very small impurities from the air.
- 4) **CABINET** - Mounts between the furnace or air handler and return air duct work and houses the COLLECTION CELLS, FIELD CHARGER and PRE-FILTER.
- 5) **POWER DOOR** - The solid state power supply components that convert the 24 Volt AC to the high-voltage, direct current required to power the FIELD CHARGER and COLLECTION CELLS. Allows access to the COLLECTION CELLS, FIELD CHARGER and PRE-FILTER.
- 6) **24 VOLT POWER CABLE**

**NOTE: International (50 Hz) Timings:**  
 Due to differences in electrical systems outside the United States, customers with 50 Hz electrical systems will need to be aware of minor differences in the timings shown in this guide. 50 Hz timings will appear in [brackets] following the standard 60 hz timings.

## DISPLAY FEATURES

The air cleaner display (Fig. 2) has the following functions:

LED and PRE-FILTER lights display the operating status of the air cleaner, indicating when to clean the PRE-FILTER or COLLECTION CELLS.

The LED display is also used in the SET-UP mode, see page 9.

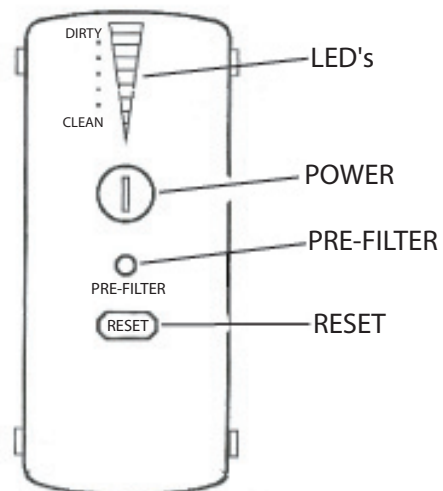

Fig. 2

# User's Information

## SEQUENCE OF OPERATION

Turn on the Trane CleanEffects™ by pressing and releasing the POWER button. The backlit POWER and RESET button will illuminate along with the first green LED indicating power is present. When the indoor fan is operating the first green LED will slowly flash. This indicates the FIELD CHARGER and COLLECTION CELLS have power and the unit is operating normally. There is a slight time delay between the indoor fan starting and LED flashing.

**NOTE:** There is a 10 [12] minute delay after the indoor fan operates, before the air cleaner starts to operate, each time the power to the air cleaner is turned off/on.

Your air filtration system only operates when the air is circulating through the indoor unit. The air filtration system is most effective at cleaning the air if the fan operates continuously. Most thermostats have a setting that will permit continuous fan operation.

**Continuous fan mode during Cooling operation may not be appropriate in humid climates. If the indoor air exceeds 60% relative humidity or simply feels uncomfortably humid, it is recommended that the fan only be used in the AUTO mode.**

In normal operation, the whole house air cleaner may make a slight sound as the air passes through it and is cleaned. In some applications, you may notice this sound coming from the return air vent(s). If desired, this sound level can be reduced with minimal impact on air cleaning efficiency by reducing the power setting of the FIELD CHARGER in the SET-UP mode (see pages 9-10).

## MAINTENANCE

### ⚠ WARNING

**RISK OF ELECTRIC SHOCK:** These servicing instructions are for use by qualified personnel only. To reduce the risk of electric shock, do not perform any servicing other than that contained in this User's Information Guide unless you are qualified to do so.

### ⚠ CAUTION

**Before cleaning the coil or ducts in the air handler or furnace, remove the COLLECTION CELLS, FIELD CHARGER, and PRE-FILTER from the air cleaner. Chemicals used during the cleaning of the air handler, furnace, or ductwork can damage the air cleaner components and degrade the performance of the air cleaner.**

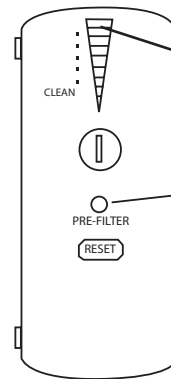

Flashing red light indicates that it is time to clean the COLLECTION CELLS

Red light indicates that it is time to clean the PRE-FILTER

**NOTE:** In a communicating system, the comfort control can be programmed to indicate when it is time to clean the filters.

For maximum efficiency, the COLLECTION CELLS and PRE-FILTER should be inspected and cleaned as prescribed in this User's Information Guide.

The FIELD CHARGER should only be removed and cleaned annually by a qualified service professional.

# User's Information

## CLEANING

Cleaning Instructions:

The air cleaner utilizes a PRE-FILTER and COLLECTION CELLS. The purpose of the PRE-FILTER is to capture large particles before they enter the COLLECTION CELLS which allows the COLLECTION CELLS to work more efficiently.

1. Turn the air conditioning system off at the Comfort Control (thermostat).

## ⚠ WARNING

**High Voltage is present within the air cleaner for operation. Before removing the Power Door, turn the power off and wait at least 15 seconds to allow voltage to discharge. Failure to follow instructions could result in death or serious personal injury.**

2. Turn off power to the air cleaner by pushing and holding the POWER button for three seconds. The LED's will remain on until the voltage has discharged and it is safe to remove the door. This requires approximately 15 seconds. **Do not remove the door until all the lights are off.**
3. Disconnect the power/control cable.
4. Rotate the two latches and remove the door as shown in Figure 3. Place the door in a secure location.
5. Remove the PRE-FILTER (Figure 4) and/or the COLLECTION CELLS (Figure 5) from the air cleaner.

## ⚠ CAUTION

**Handle the door only by using the handles on the front of the door. Grasp the door by the handles as depicted in Figure 3 to remove and replace the door. Do not handle the door on the edges. Metal edges may be sharp and could result in injury if the door is not handled properly.**

Before removing the door from the unit, remove the power cable plug from the socket located in the corner of the door.

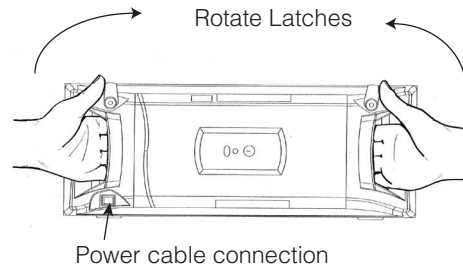

Fig. 3

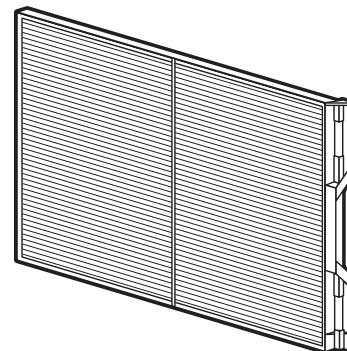

Fig. 4

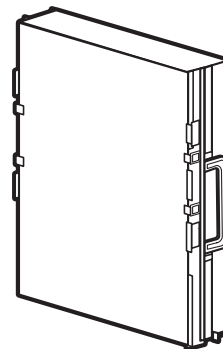

Fig. 5

# User's Information

## VACUUM CLEANING

Vacuuming is the preferred method to clean the PRE-FILTER and COLLECTION CELLS. It is recommended that the PRE-FILTER and the COLLECTION CELLS be vacuumed outside the home to ensure particles on the filters are not reintroduced into the air. Persons highly sensitive to the collected particles should wear appropriate respiratory protection while cleaning.

### PRE-FILTER –

It is time to clean the PRE-FILTER when the red “PRE-FILTER” light (shown in Figure 6) is illuminated.

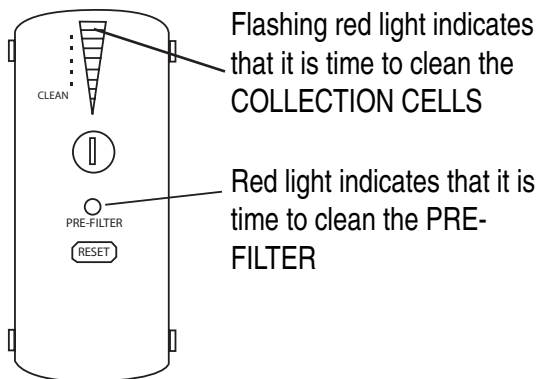

Flashing red light indicates that it is time to clean the COLLECTION CELLS

Red light indicates that it is time to clean the PRE-FILTER

Fig. 6

The air cleaner is factory set to notify the home owner to clean the PRE-FILTER every two months [10 weeks] of actual run time of the air cleaner. This notification can be changed by the installer/home owner to 1 month or 3 months [5 to 15 weeks] depending on the conditions in the home (pets, smokers, etc.). Please see “SET-UP MODE” (Page 9) to change the factory settings.

1. Using a vacuum hose, vacuum in even strokes across the length of the PRE-FILTER. After vacuuming the entire PRE-FILTER using even strokes going in one direction, repeat the process using even strokes going in the opposite direction as shown in Figure 7.

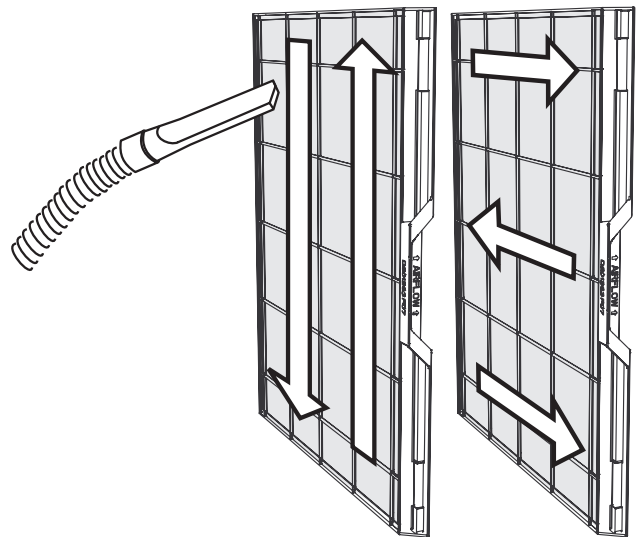

Fig. 7

**NOTE: Do NOT replace the plastic PRE-FILTER with a metal type PRE-FILTER. A metal PRE-FILTER will cause reduction in efficiency and potential failure of the electronics in the air cleaner.**

### COLLECTION CELLS

The clean/dirty LED light bar indicator will illuminate as the system cleans the air. The LED lights will progress from green to yellow and then to red. When the last red indicator is flashing, it is time to clean the COLLECTION CELLS (see Figure 6). The air cleaner is factory set to notify the home owner to clean the COLLECTION CELLS every six months [31 weeks] of actual run time of the air cleaner. This notification can be changed by the installer/home owner to 2 months, 4 months, 6 months, or 9 months [10, 20, 31 or 46 weeks] depending on the conditions in the home (pets, smokers, etc.). Please see “SET-UP MODE” (Page 9) to change the factory settings.

# User's Information

- Using a vacuum hose, vacuum in even strokes across the entire COLLECTION CELL surface. Vacuum using even strokes in one direction, then repeat the process using even strokes in the opposite direction, as demonstrated in Figure 8 below.

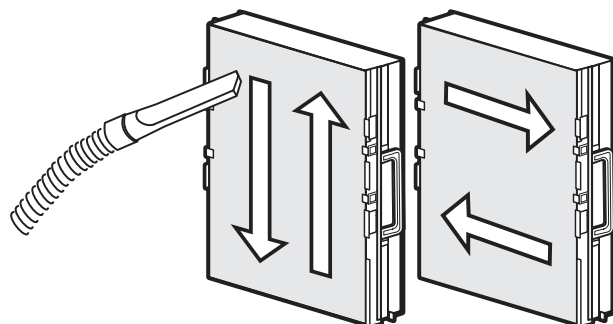

Fig. 8

- Once vacuuming is completed on one side of the COLLECTION CELL, turn the COLLECTION CELL over and repeat on the other side of the COLLECTION CELL.

**NOTE: It is normal for COLLECTION CELLS to discolor during operation. Vacuuming will not restore the COLLECTION CELLS to their original color. However, vacuuming does restore the COLLECTION CELLS to a high efficiency.**

## REPLACING THE PRE-FILTER AND COLLECTION CELLS INTO THE AIR CLEANER

- Replace the PRE-FILTER into the air cleaner. Ensure that the "AIRFLOW indicator arrow" on the PREFILTER is pointing in the same direction as the "AIRFLOW indicator arrow" on the air cleaner cabinet.

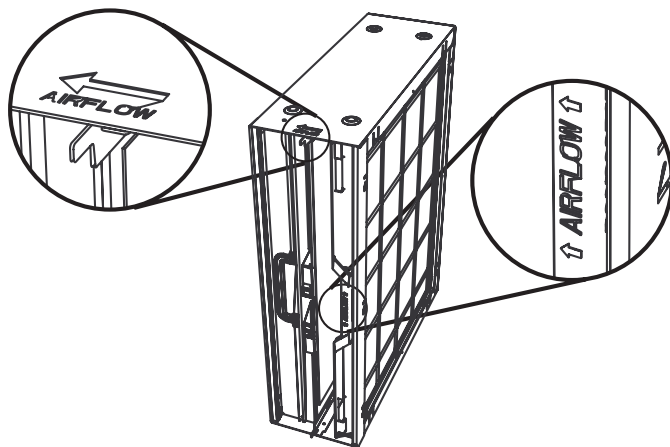

Fig. 9

- Reinstall the COLLECTION CELLS into the air cleaner. Ensure the handles on both of the COLLECTION CELLS are folded flat.

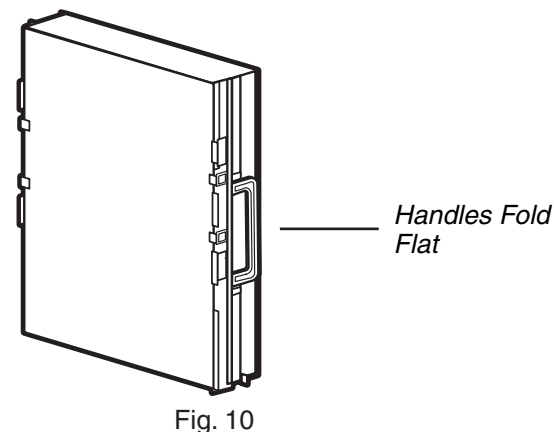
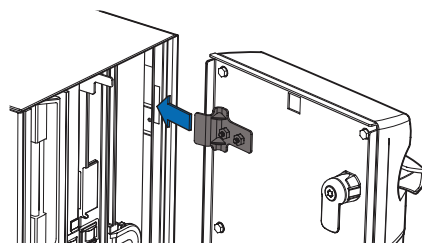

Fig. 10

- Replace the power door onto the air cleaner.

To install the door, follow the instructions in Figures 11 - 14 below.



Hold door so that tabs are aligned with slots in cabinet.

Fig. 11

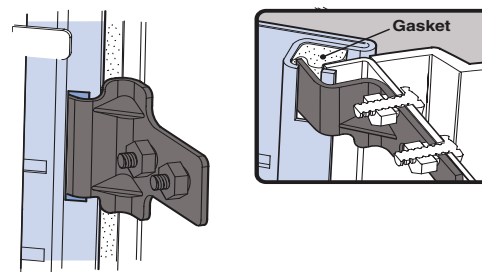

Fig. 12

Insert tabs into cabinet slots. Edge of door should fit into channel against gasket. (See detail)

# User's Information

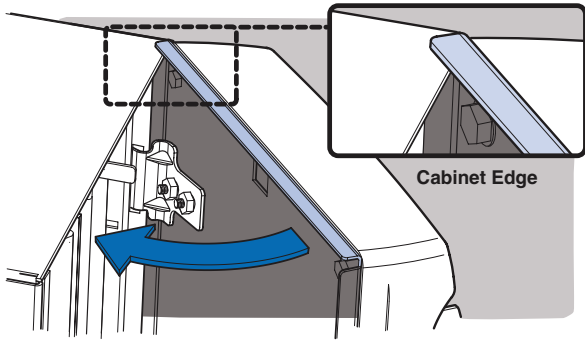

Fig. 13

Rotate door to closed position. Ensure ends of door overlap cabinet. (See detail)

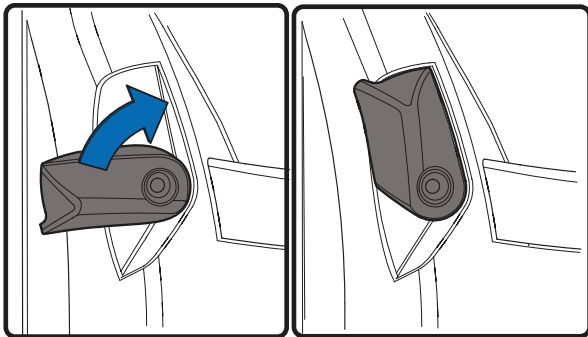



Fig. 14

Rotate latches to secure door.

4. Ensure the power cord is plugged into the air cleaner.
5. Press the POWER button  to turn on the air cleaner.

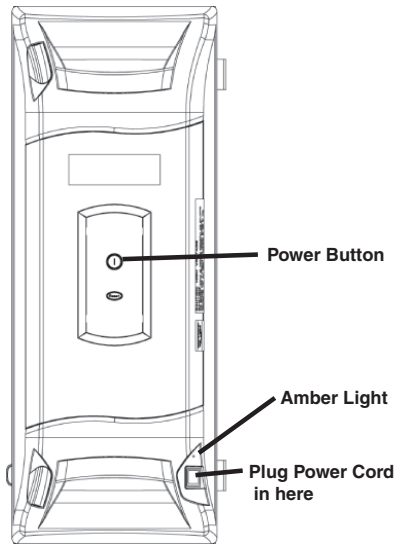

Fig. 15

The whole house air cleaner can be connected in one of two modes of operation; either a 24 V mode or a communicating mode. To know how the whole house air cleaner is set up, reference Figure 15 to find the amber light.

A steady amber light indicates that the unit is wired in the 24 V mode.  
 A blinking amber light indicates that the unit is wired in the communicating mode.  
 No light present means that the unit is not connected.

**NOTE:** Once you press the POWER button, the first LED will be on and it will start flashing after the first 10 [12] minutes of indoor fan operation. This is normal operation.

### Alternate Cleaning option for homeowners with 200 or 200-1 COLLECTION CELLS ONLY

Vacuuming the PRE-FILTER and COLLECTION CELLS restores them to a high efficiency. However, some environmental conditions, like tobacco smoke, cause the COLLECTION CELLS to need to be washed with water. Washing the COLLECTION CELLS is acceptable ONLY if the COLLECTION CELL has a “200/200-1” embossed or written on the frame in the vicinity of the manufacturing part number:

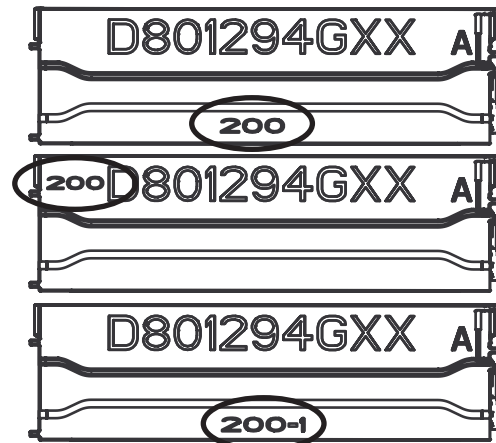

Fig. 16

Carefully review **BOTH** of the COLLECTION CELLS for the “200/200-1” mark. If the “200/200-1” mark is visible on **BOTH** COLLECTION CELLS, they may be washed. If the “200/200-1” mark is **NOT** visible, the COLLECTION CELLS **cannot** be washed.

## CAUTION

**Washing COLLECTION CELLS that do NOT have the “200/200-1” mark on them can result in degradation of the air cleaner system. Failure to follow instructions could result in property damages.**

1. If the COLLECTION CELLS do have the “200/200-1” mark on them, they may be washed using a low pressure water spray, such as a sink sprayer or garden hose. Residue like tobacco smoke may require warm water to be removed.

- Do NOT use soap or detergent in cleaning the COLLECTION CELLS.
- Do NOT immerse the COLLECTION CELLS completely in water.
- Do NOT place the COLLECTION CELLS into a dishwasher to clean.
- ALLOW THE COLLECTION CELLS TO DRY THOROUGHLY BEFORE INSTALLING.



- After washing, drain as much water as possible from the COLLECTION CELLS.
- Holding the sides of the COLLECTION CELLS, gently tap the cells on a flat surface to dislodge any water droplets inside the COLLECTION CELLS. After tapping, wipe down the surfaces of the COLLECTION CELLS to remove any visible droplets of water.

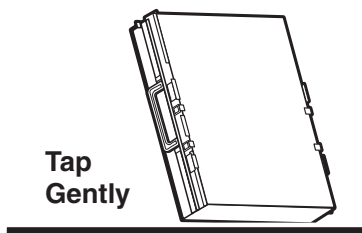

Fig. 17

- When there are no visible water droplets left in the COLLECTION CELLS, reinstall them into the air cleaner cabinet. Be sure to fold the COLLECTION CELL handles flat.

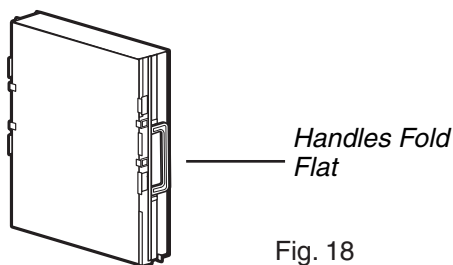

Fig. 18

## RESET TIMERS

When installed as part of a Communicating System with a 900 series comfort control, the filter timers can be reset at either the Comfort Control or the air cleaner.

To reset the Pre Filter timer at the comfort control Select Filter 1 Change Reminder, then press the MORE key to access the filter timer value and then press the RESET key.

To reset at the air cleaner press and hold the RESET key until the PREFILTER LED turns off (1 to 2 seconds).

To reset the Collection Cell timer at the Comfort Control select Filter 2 Change Reminder, then press the More key to access the filter timer value and then press the Reset key.

To reset the Collection Cell timer at the air cleaner press and hold the RESET key until the COLLECTION CELL LED turns off (1 to 2 seconds).

If two air cleaners are connected on the same system, reset all timers on both air cleaners at the same time to the same settings. The comfort control will only report one air cleaner timer and this methodology will allow the air cleaners to remain on the same cleaning schedule. For additional information please refer to the Installers Guide and/or Service Facts for the 900 Series control. However, in a system with dual air cleaners, the 900 series comfort control will only recognize the timer for one air cleaner. Reset the filter timer at the comfort control using the instructions given above.

**NOTE:** If collection cells are wet, you may see a fault indication. Turn air cleaner off until collection cells are completely dry.

## SET-UP MODE

You can customize the operation of the CleanEffects™ air cleaner to meet the needs of your home and family using the SET-UP mode. The Comfort Control should be in "Auto Detect" mode.

To enter the SET-UP mode, press and hold BOTH the POWER and the RESET buttons for a minimum of 5 [6] seconds. The LED display will light up indicating the current settings. If the settings were not changed during installation into your home, the LED's will light up with the factory settings as shown in Figure 19.

## Factory settings

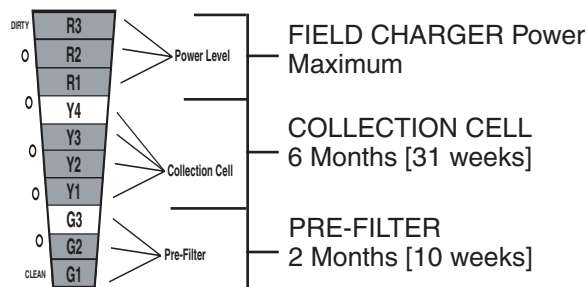

Fig. 19

You may select the cleaning intervals of the PRE-FILTER and the COLLECTION CELLS as well as the power setting of the FIELD CHARGER by cycling through the various settings. Once you have made the desired changes, press and hold BOTH the POWER and the filter RESET buttons for a minimum of 5 [6] seconds to exit the SET-UP mode.

## PRE-FILTER Timer Setting

The GREEN LED lights are used to set the PRE-FILTER cleaning interval for one, two, or three months [5, 10, or 15 weeks]. The number of illuminated GREEN LED lights indicates the current setting. The factory setting is 2 months [10 weeks] of run time (see Figure 19).

## COLLECTION CELL Timer Setting

The YELLOW LED lights are used to set the COLLECTION CELLS cleaning interval for two, four, six, or nine months [10, 20, 31, or 46 weeks]. The number of illuminated YELLOW LED lights indicates the current setting as shown in Figure 19. The factory setting is 6 months [31 weeks] of run time.

# User's Information

## FIELD CHARGER Power Level Setting

The RED LED lights are used to set the power level of the FIELD CHARGER for maximum, medium, or minimum. The number of illuminated RED LED lights indicates the current setting as shown in Figure 22. The factory setting is for maximum.

Lower settings will reduce the slight sound emitted by the unit with minimal loss of air cleaning efficiency, if desired.

The U.S. Food and Drug Administration recommends indoor ozone concentrations should not exceed 50 parts per billion. Your air cleaner will contribute a negligible amount of ozone - less than .3 parts per billion to the living space.

## CHANGING THE SETTINGS

While in the SET-UP mode, press the POWER button  once to begin cycling through the various setting options in the following order:

## PRE-FILTER Cleaning Interval Setting (Figure 20)

One or more of the GREEN LED lights will illuminate. To change the reminder interval time, press the RESET button until the desired setting is indicated, and then press the POWER button again. Choices are in months of "run time", not a calendar month.

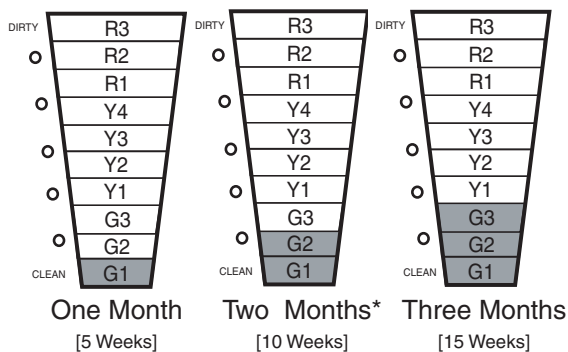

Fig. 20

## COLLECTION CELLS Cleaning Interval Setting (Figure 21)

One or more of the YELLOW LED lights will illuminate. To change the reminder interval time, press the RESET button until the desired setting is indicated, and then press the POWER button again.

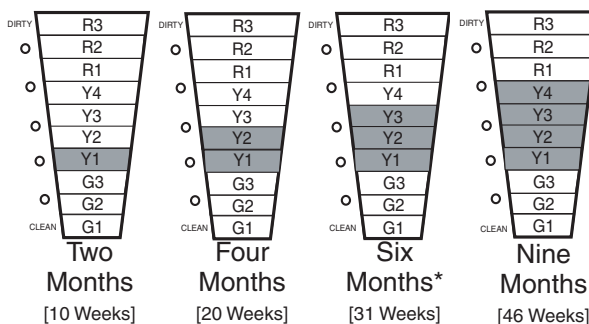

Fig. 21

## FIELD CHARGER Power Level Setting (Figure 22)

One or more of the RED LED lights will illuminate. To change the power level setting, press the RESET button until the desired setting is indicated.

To save your new settings and exit the SET-UP mode, press and hold BOTH the Power and filter RESET buttons for a minimum of 5 [6] seconds.

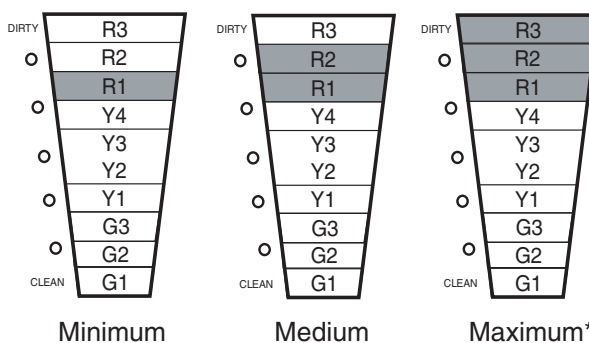

Fig. 22

\* Factory settings

## FAULT INDICATORS

In communicating systems, the whole house air cleaner faults are reported to the comfort control. When an alert is present on the comfort control, see the Alert Code Addendum that is shipped with the comfort control to view the corresponding alert code and if it is related to the whole house air cleaner.

The air cleaner has been designed to continually monitor itself to insure it is working properly. If it detects a problem, three of the four YELLOW LED lights will flash continuously. See Figure 23.

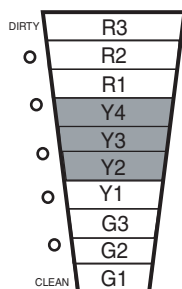

Fig. 23

### ⚠ WARNING

**High Voltage is present within the air cleaner for operation. Before removing the Power Door, turn the power off and wait at least 15 seconds to allow voltage to discharge. Failure to follow instructions could result in death or serious personal injury.**

If this fault occurs:

- 1) Turn off power to the air cleaner by pushing and holding the POWER button for three seconds.

The LED's will remain on until the voltage has discharged and it is safe to remove the door. This requires approximately 15 seconds. **Do not remove the door until all the lights are off.**

- 2) Clean both the PREFILTER and the COLLECTION CELLS to insure no large material is trapped in the filters and causing the fault. See pages 4-9 for cleaning information.

**NOTE:** If collection cells are wet, you may see this fault indication. Turn air cleaner off until collection cells are completely dry.

If the unit detects any other type of fault, all three RED LED lights will flash continuously as shown in Figure 24. The filter will shut down and does not represent a safety risk. You should call a qualified service technician for service.

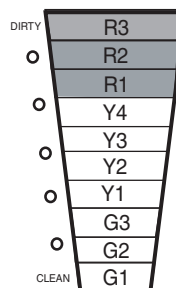

Fig. 24

## SYSTEM INFORMATION

### ⚠ CAUTION

**Before cleaning the coil or ducts in the air handler or furnace, remove the COLLECTION CELLS, FIELD CHARGER, and PRE-FILTER from the air cleaner. Chemicals used during the cleaning of the air handler, furnace, or ductwork can damage the air cleaner components and degrade the performance of the air cleaner.**

### ⚠ CAUTION

**Do not install air cleaner where the filter can be exposed to UV light. UV light can cause the plastic material to deteriorate, which may lead to filter damage.**



**Trane**  
**6200 Troup Highway**  
**Tyler, TX 75707**

*For more information contact  
your local dealer (distributor)*

---

---

---

---

---

06/13

*Since the manufacturer has a policy of continuous product and product data improvement, it reserves the right to change design and specifications without notice.*